

# ECLIPSE®

## DECK SURFACE INSTALLATION



**GRUB-SCREWS ARE IN PLACE TO PROTECT THE THREADED HOLES ON BASES DURING SHIPPING AND STORAGE. THEY MUST BE REMOVED AND DISCARDED BEFORE THE INSTALLATION OF ANY UMBRELLA.**

Your Eclipse® Cantilever comes with the Spigot already inserted in the mast of your umbrella. Once you have properly installed to your selected mount/base option, remove the Spigot from your umbrella and you can begin to mount your Spigot to the Deck Plate, and then the umbrella (see **FIGURE 5**).

### TOOLS & MATERIALS NEEDED

- Power Drill
  - 1/2" - 1" Open ended or Box Wrench
  - 1/2" - 1" Ratchet Wrench
  - Level
  - Tape Measure
  - Wood Brace Block - 2" x "Distance of your joists under the deck planks" (2" minimum)
  - (8) "Big Timber #9" Coarse Wood Screws
  - (4) 1/2" x 4" Socket Countersunk Flat Head Screws
  - (4) 1/2" Hex Nuts
  - (4) 1.5" OD (outside diameter) Fender Washers / 1/2" ID (inside diameter)
1. Unpack your Deck Plate and place into the position you plan on installing your cantilever umbrella. Evenly place across wood planks (**FIGURE 1**) and be sure you are between deck joists. Use your drill with a 1/2" drill bit, place your foot with a good amount your weight on the deck plate (**FIGURE 1-A**), and drill out the outer holes (**FIGURE 1 :magenta:**) through your mounting planks.
  2. With the holes drilled, remove your Deck Plate, and begin to remove the adjacent wood planks. Enough space for a visual of the deck joists (**FIGURE 1**).
  3. Measure the width between your joist and cut your wooden brace block to size (**FIGURE 2**). Using "Big Timber #9" or another generic outdoor wood screw, begin to secure the brace block into place against the joists and firmly up against the mounting wood planks (**FIGURE 2-A :magenta:**).
  4. Now that the brace block is secure, move your attention to the four holes drilled for the Deck Plate mounting. Using the same drill bit to initially set the pattern placement, drill clean through the brace block (**FIGURE 3**).
  5. With clear holes drilled through the planks and the brace block, place the Deck Plate back in place, and drop in your 1/2" x 4" (adjust to specific depth) countersunk flat head screws. Place the fender washer and nut on the underside and hand tighten.
  6. With the bolts hand tight, use your box or open wrench to hold the nut on the underside in place, and torque down firmly using the ratchet on the topside (**FIGURE 4**). Once the Deck Plate is firmly secure, replace the wooden planks you have removed in the beginning of the installation.
  7. Retrieve the Spigot from your umbrella. It will already be inserted into the mast. Place the Spigot on the Deck Plate lining up the inner four bolts. Using the supplied hardware that is packed with your umbrella, bolt the Spigot onto the Deck Plate (**FIGURE 5**). Once your Spigot is secure to the Deck Plate, begin to lift the Eclipse® onto the Spigot until you hear an audible "click" indicating your umbrella is secure.

### INCLUDED DECK PLATE SPECIFIC MOUNTING HARDWARE

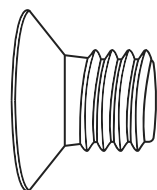

X4

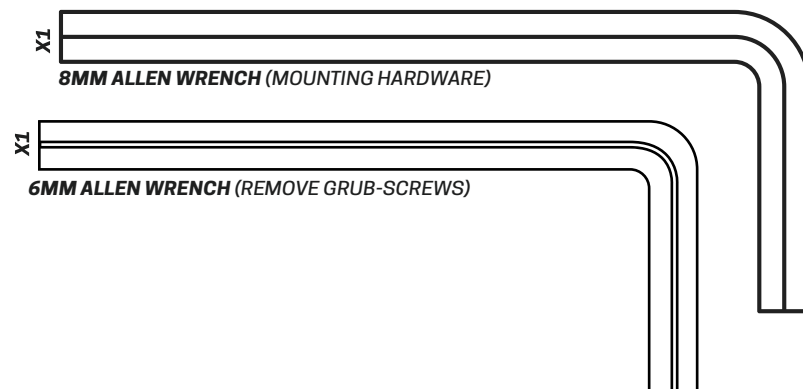

FIGURE 1

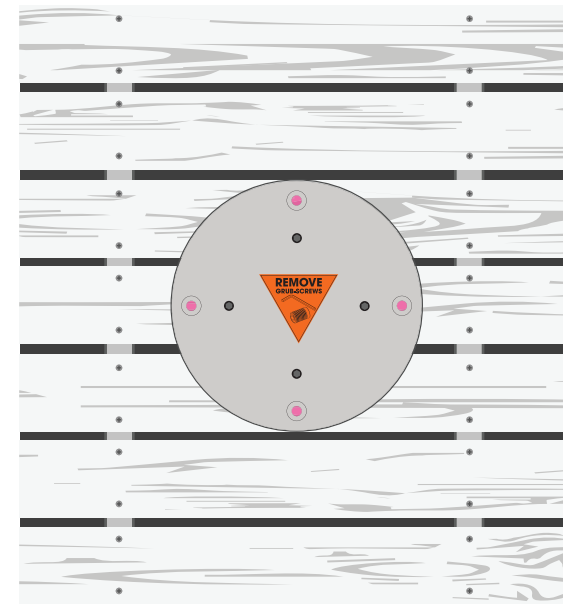

FIGURE 1-A

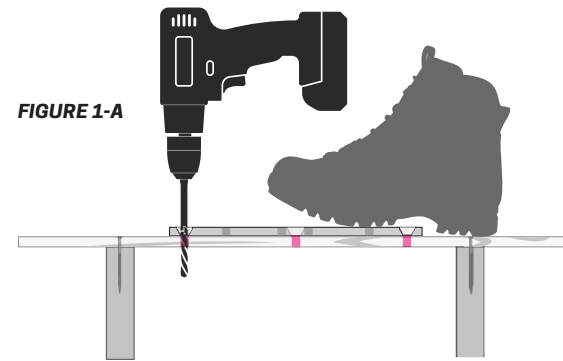

FIGURE 2

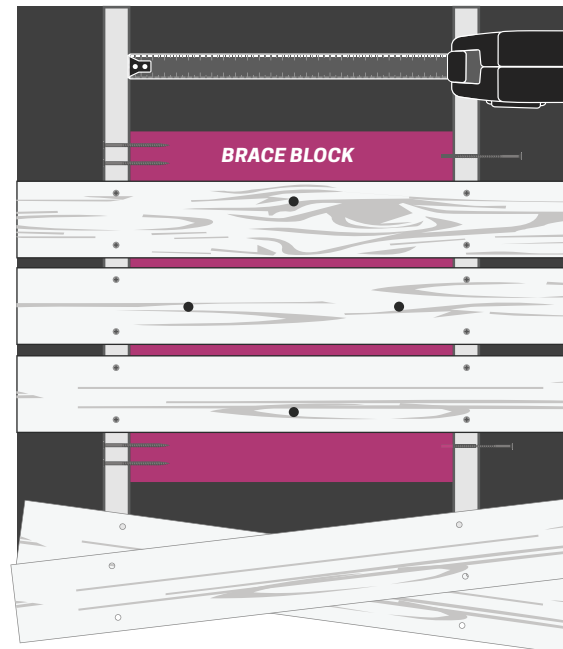

FIGURE 2-A

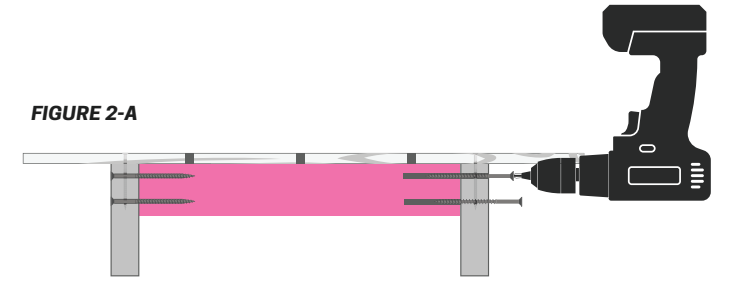

FIGURE 3

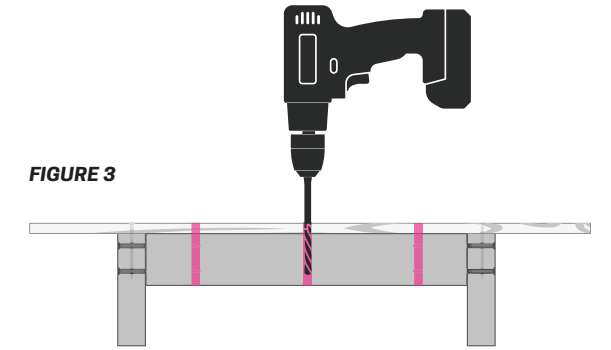

FIGURE 4

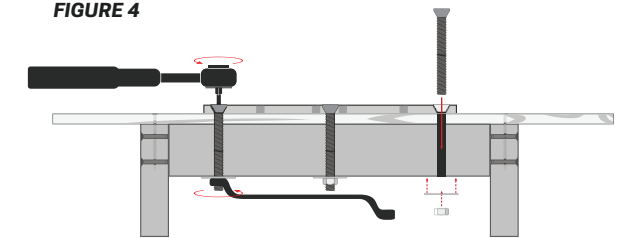

FIGURE 5

